

## Product overview

# NXP SPEAKERS

- RA8x12x2.5
- RA9.6x13.6x2.9
- RA11x15x3.5
- RA13x18x4.5
- SALT 13x4.2
- GRACE 14x20x4
- MALT EVA 16x3
- MFD 16.4x4.7 Multifunctional Vibrator
- HPFS 28x6

**New!**



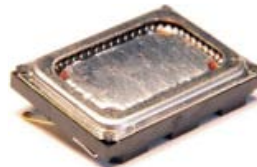



**New!**

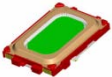

March 11

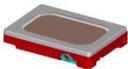
## Portfolio

### Portfolio : NXP Speakers

SPEAKER MODEL	Picture	Dimension (mm)	Impedance ( $\Omega$ )	Nom./Max. power (mW)	SPL* @ 1W/1m (dB)	Fo (Hz)	Frequency range (Hz)	Recommended back volume
<a href="#">RA8x12x2.5</a>		8 x 12 x 2.5	8	250/500	68	630	800 - 20000	0.5 ccm
<a href="#">RA9.6x13.6x2.9</a>		9.6 x 13.6 x 2.9	8	300/700	70	520	750 - 20000	0.75 ccm
<a href="#">RA11x15x3.5</a>		11 x 15 x 3.5	8	500/1000	73	450	650 - 16000	1 ccm
<a href="#">RA13x18x4.5</a>		13 x 18 x 4.5	8	700/1000	76	500	600 - 10000	1 ccm
<a href="#">SALT 13x4.2</a>		$\varnothing$ 13 x 4.2	8	300/600	79	1000	600 - 10000	
<a href="#">GRACE 14x20x4</a>		14 x 20 x 4	8	500/1000	77.5	950	1000 - 15000	open backvolume possible
<a href="#">MALT EVA 16x3</a>		$\varnothing$ 16 x 3	8	300/800	74.5	600	700 - 10000	2 ccm
<a href="#">MFD16 Multifunctional vibrator</a>		$\varnothing$ 16.4 x 4.76	8	500/1000	74	540	650 - 15000	2 ccm
<a href="#">HPFS 28x6</a>		$\varnothing$ 28 x 6	8	500/1000	86.5	700	450 - 8000	

\*) calculated for all speakers with nominal power < 1000mW

## RA8x12x2.5

### Speaker RA 8 x 12 x 2.5mm :

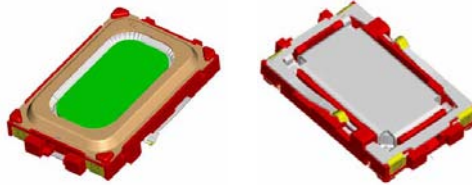

### Specifications :

- **Impedance :** 8Ω
- **Sensitivity :** 68dB @ 1W/1m
- **Power Ratio \*\* :** 0.25W Nom. / 0.5W Max
- **Resonance Frequency :** 630Hz
- **Frequency Range \* :** 1800Hz – 20kHz
- **Weight :** 0.8g
- **Thickness :** 2.5mm

\*) in typical application, at -3dB points after resonance peaks, without EQ correction

\*\*) using shaped noise signal according to NXP specification sheet

### Key features :

- Easy mechanical integration due to rectangular shape
- Low Resonance frequency, for use with small backvolumes
- Unique mechanical design yields extremely high soundflow
- Compound membrane for minimum THD, Q-factor and tumbling
- Robust design & spring contacts for easy application

### Product range :

- 2403 260 00029 : with spring contacts

### Frequency Response : measured in IEC baffle with open back volume (50mW, 1cm)

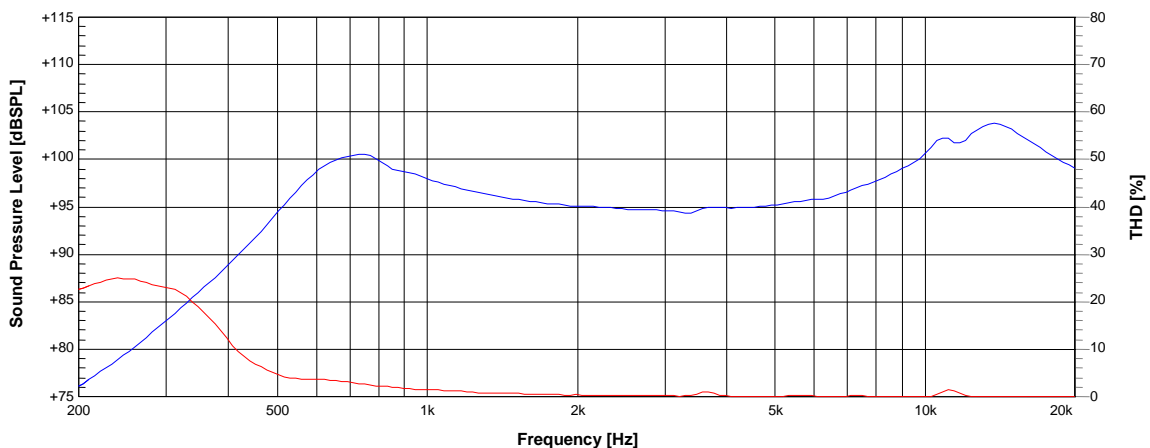

[Back](#)

## RA8x12x2.5

### Speaker RA 8 x 12 x 2.5mm :

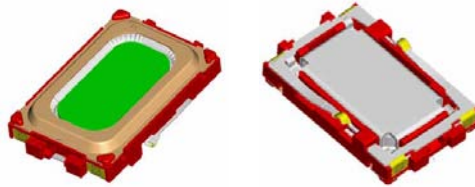

### Typical applications :

- For operation in closed back volumes (typically  $F_0 = 900\text{Hz}$  in 0.5 ccm)
- Especially designed for stereo applications
- For front & side firing designs, flipped usage possible

### Flipped design :

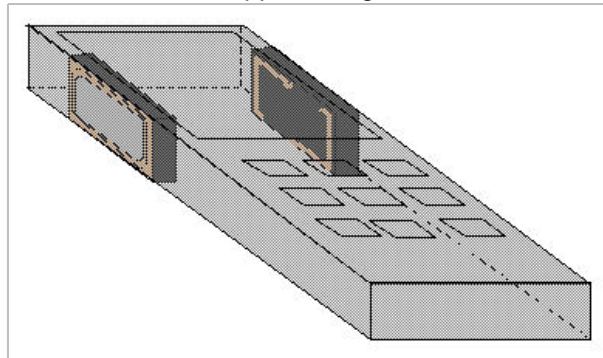

### Typical frequency response in free field in 3,16cm distance

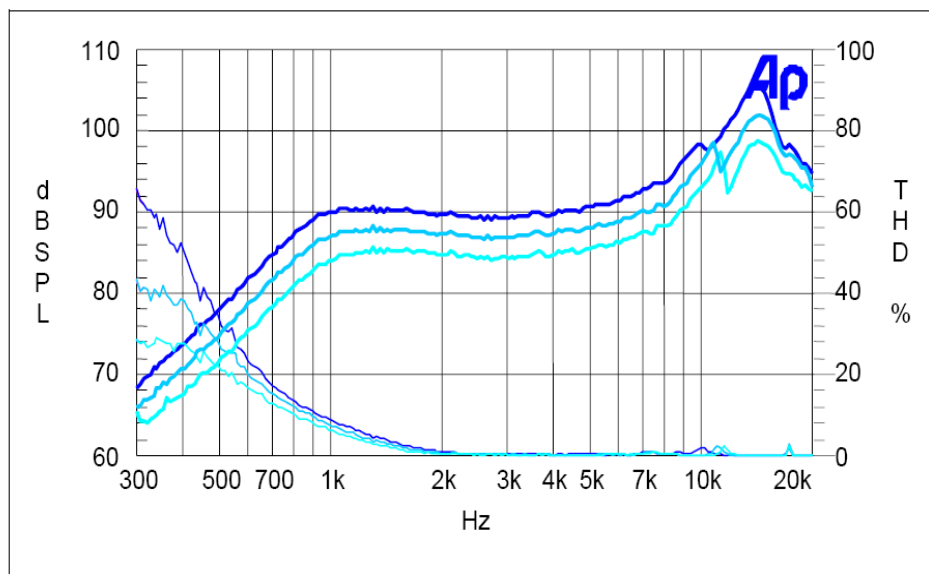

Figure 1: 0,5ccm back volume, free filed 3,16cm distance, 75 – 150 –300mW

[Back](#)

## RA9.6x13.6x2.9

### Speaker RA 9.6 x 13.6 x 2.9mm :



### Specifications :

- **Impedance :** 8Ω
- **Sensitivity :** 70dB @ 1W/1m
- **Power Ratio \*\* :** 0.3W Nom. / 0.7W Max
- **Resonance Frequency :** 520Hz
- **Frequency Range \* :** 750Hz – 20kHz
- **Weight :** 0.7g
- **Thickness :** 2.9mm

\*) in typical application, at -3dB points after resonance peaks, without EQ correction

\*\*) using shaped noise signal according to NXP specification sheet

### Key features :

- Easy mechanical integration due to rectangular shape
- Low Resonance frequency, for use with small backvolumes
- Smallest available component with sufficient sound performance for mono applications
- Compound membrane for minimum THD, Q-factor and tumbling
- Robust design & spring contacts for easy application

### Product range :

- 2403 260 00044 : with spring contacts

### Frequency Response : measured in IEC baffle with open back volume (100mW, 1cm)

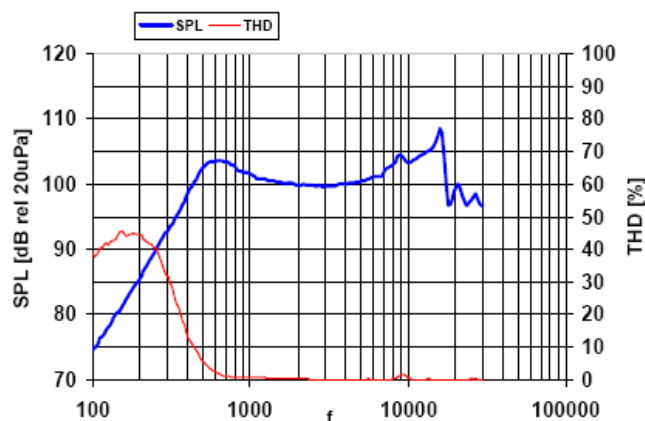

[Back](#)

## RA9.6x13.6x2.9

Speaker RA 9.6 x 13.6 x 2.9mm :



### Typical applications :

- For operation in closed back volumes (typically  $F_0 = 800\text{Hz}$  in 1 ccm)
- Suits both mono and stereo applications
- For front & side firing designs

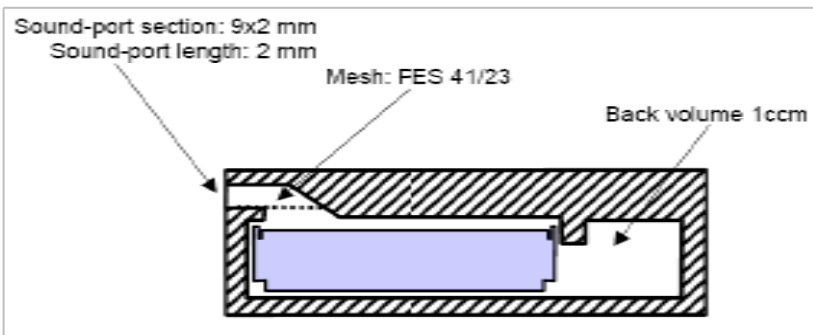

Using a mesh in front of the sound port prevent the speaker from dust particles and reduces the membrane movement as well (which will increase the reliability).  
Reducing the front volume according above schematic drawing will shift the second resonator to higher frequencies.

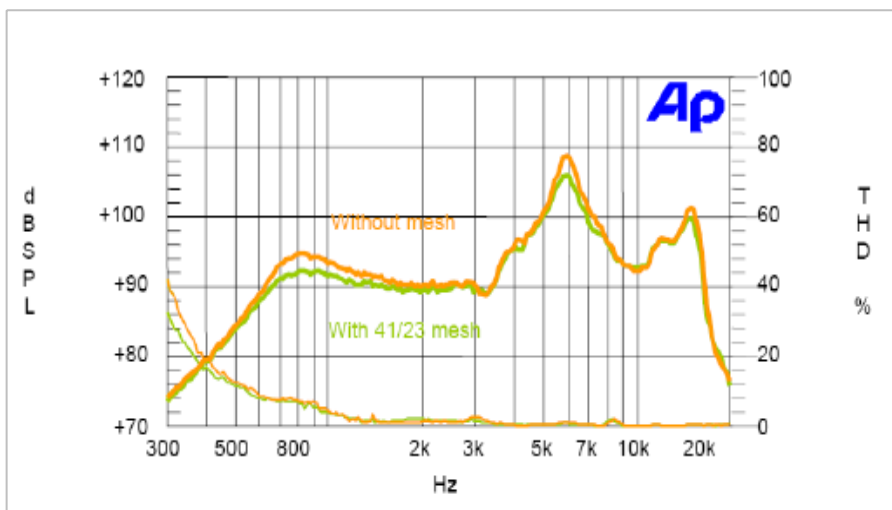

Frequency response with/without mesh (3,16cm Distance free field at 250mW).  
The peak between 5kHz and 7kHz is caused by the front resonator and can be easily corrected with DSP.

[Back](#)

## RA11x15x3.5

### Speaker RA 11 x 15 x 3.5mm :

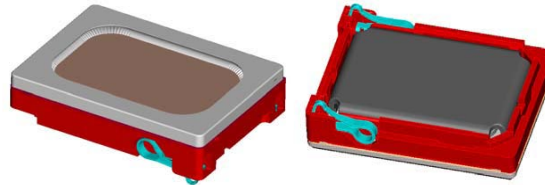

### Specifications :

- **Impedance :** 8Ω
- **Sensitivity :** 73dB @ 1W/1m
- **Power Ratio \*\* :** 0.5W Nom. / 1W Max
- **Resonance Frequency :** 450Hz
- **Frequency Range \* :** 650Hz – 16kHz
- **Weight :** 1.5g
- **Thickness :** 3.5mm

\*) in typical application, at -3dB points after resonance peaks, without EQ correction

\*\*) using shaped noise signal according to NXP specification sheet

### Key features :

- Easy mechanical integration due to rectangular shape
- Low Resonance frequency, for use with small backvolumes
- 50% less back cavity necessary compared to typical 16mm speaker
- Unique mechanical design yields extremely high soundflow
- Compound membrane for minimum THD, Q-factor and tumbling

### Product range :

- 2403 260 00001 : with spring contacts (WD35623/Y8L)
- 2403 262 00052 : with adhesive foamgasket

### Frequency Response : measured in IEC baffle with open back volume (50mW, 1cm)

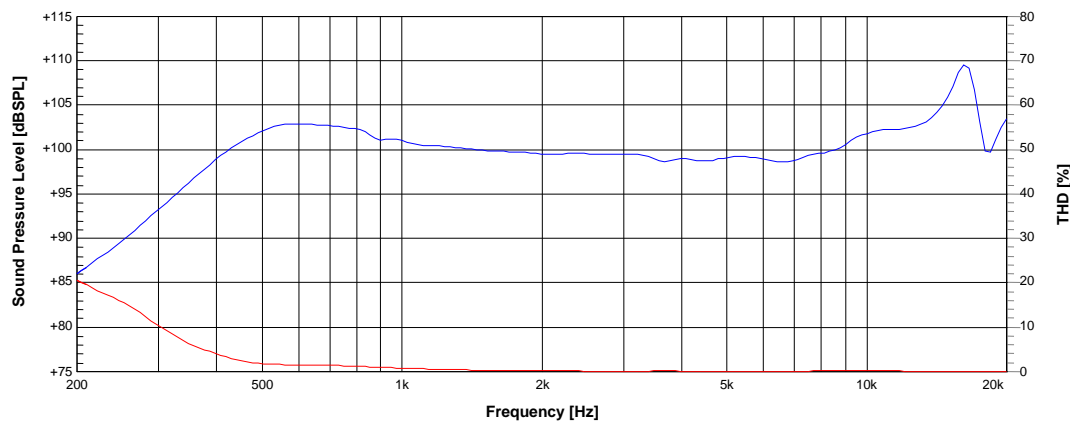

[Back](#)

## RA11x15x3.5

### Speaker RA 11 x 15 x 3.5mm :

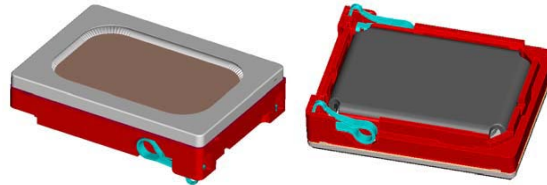

### Typical applications :

- For operation in closed back volumes (typically 1ccm)
- Suits both mono and stereo applications
- For front & side firing designs

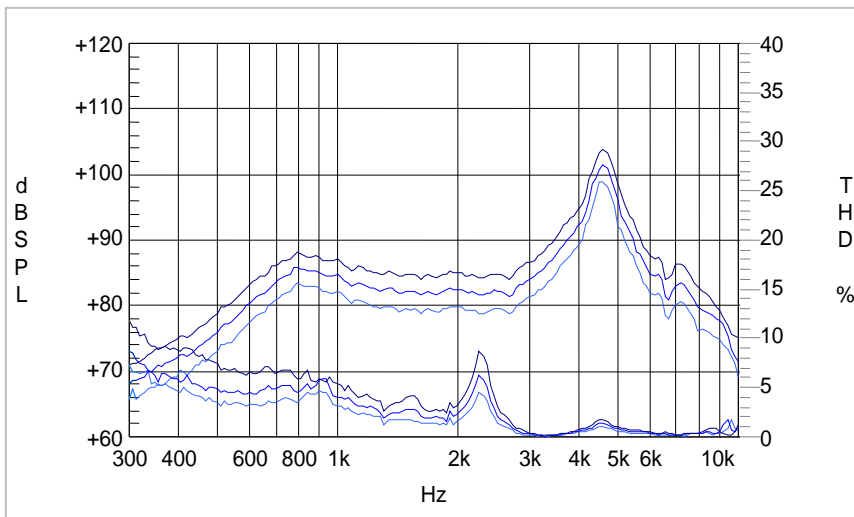

**One speaker (1ccm back volume)  
in 10cm free field**  
Measured in 10 cm (Y direction)  
at 125–250–500 mW

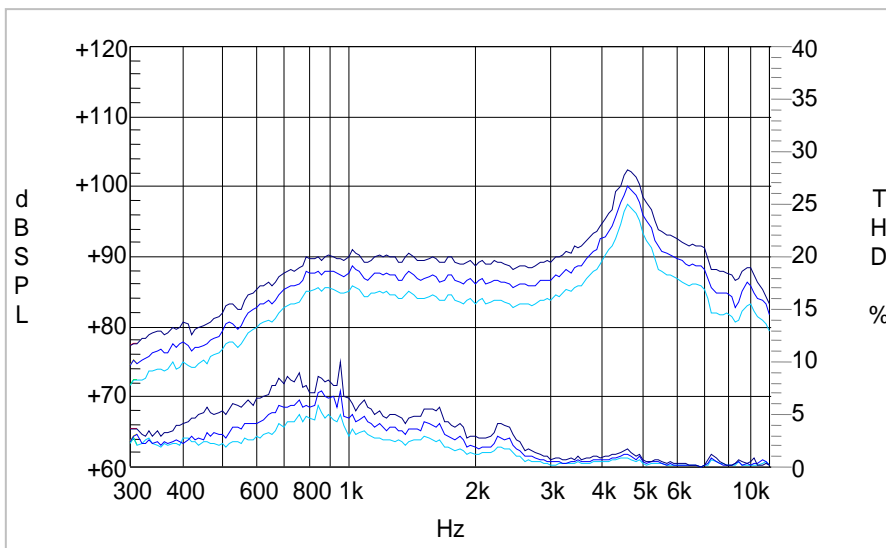

**Two speakers (each 1ccm back volume)  
in parallel in 10cm free field**  
Measured in 10 cm (Z direction) free field  
at 200–400–800mW (LS in parallel, 4 Ohm)

## RA13x18x4.5

Speaker RA 13 x 18 x 4.5mm :

**New product**



### Specifications :

- **Impedance :** 8Ω
- **Sensitivity :** 76dB @ 1W/1m
- **Power Ratio \*\* :** 0.7W Nom. / 1W Max
- **Resonance Frequency :** 500Hz
- **Frequency Range \* :** 600Hz – 10kHz
- **Weight :** 2.5g
- **Thickness :** 4.5mm

\*) in typical application, at -3dB points after resonance peaks, without EQ correction

\*\*) using shaped noise signal according to NXP specification sheet

### Key features :

- Optimized for maximum SPL
- Easy mechanical integration due to rectangular shape
- Compound membrane for minimum THD, Q-factor and tumbling
- Increased Power Handling Capacity

### Product range :

- 2403 260 00063 : with spring contacts

**Frequency Response :** measured in IEC baffle with 1ccm back volume (70mW, 1cm)

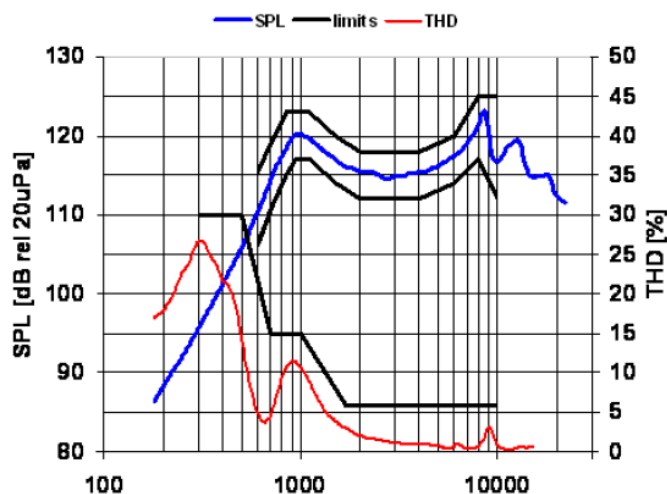

## RA13x18x4.5

Speaker RA 13 x 18 x 4.5mm :



**Typical applications :**

- For operation in closed back volumes (typically 0.5...2 ccm)
- Suits both mono and stereo applications
- For front & side firing designs

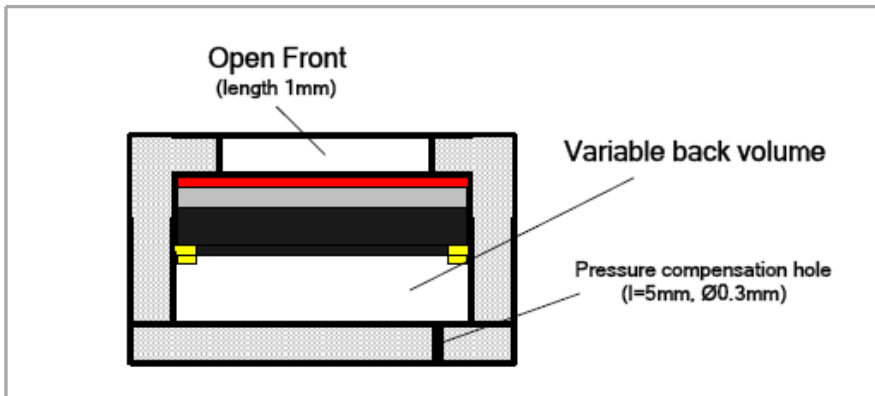

**Measurement setup:**  
The back volume is varied between 0.5ccm and 2ccm. The frequency response and the THD get measured for each volume

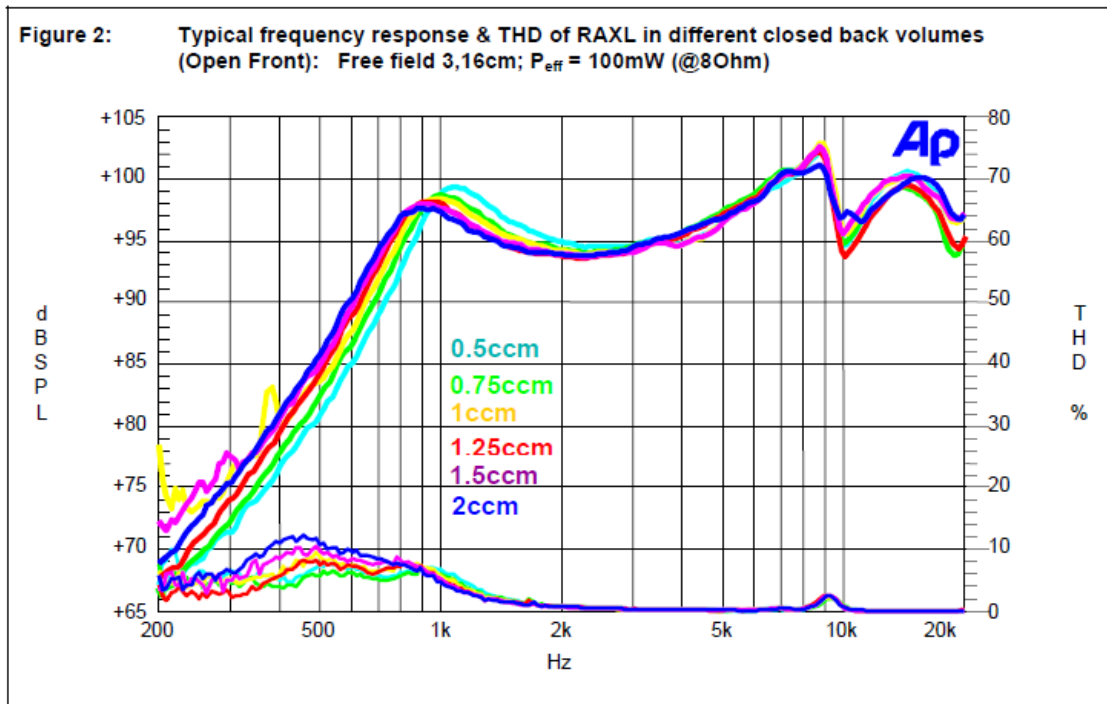

[Back](#)

## SALT 13x4.2

Speaker SALT 13 x 4.2mm **multifunctional** :



### Specifications :

- **Impedance :** 8Ω
- **Sensitivity :** 79dB @ 1W/1m
- **Power Ratio \*\* :** 0.3W Nom. / 0.6W Max
- **Resonance Frequency :** 1000Hz
- **Frequency Range \* :** 600Hz – 10kHz
- **Weight :** 1.2g
- **Thickness :** 4.15mm

\*) in typical application, at -3dB points after resonance peaks, without EQ correction

\*\*) using shaped noise signal according to NXP specification sheet

### Key features :

- Variable contact solutions
- Two mode transducer
- Low Resonance frequency
- High sensitivity

### Typical applications :

- Clamshell mobile phones
- Slider mobile phones
- For sealed and unsealed applications

### Product range :

- 2403 263 00009 : with spring contacts (WD00553/Y8L)

**Frequency Response :** measured in IEC baffle with open back volume (2mW, 10cm)

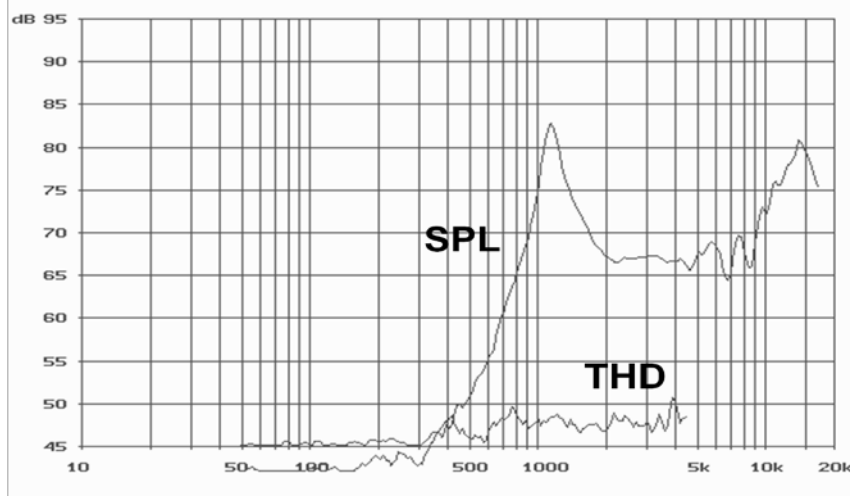

[Back](#)

## GRACE 14x20x4

### Speaker GRACE 14 x 20 x 4mm :



### Specifications :

- **Impedance :** 8Ω
- **Sensitivity :** 77.5dB @ 1W/1m
- **Power Ratio \*\* :** 0.5W Nom. / 1W Max
- **Resonance Frequency :** 950Hz
- **Frequency Range \* :** 1000Hz – 15kHz
- **Weight :** 1.7g
- **Thickness :** 4.0mm

\*) in typical application, at -3dB points after resonance peaks, without EQ correction

\*\*) using shaped noise signal according to NXP specification sheet

### Key features :

- High sound pressure level
- High sensitivity & power handling
- Oval racetrack design for space saving mounting

### Product range :

- 2403 263 00046 : with spring contacts
- 2403 263 00037 : with solder pads

### Frequency Response : measured in IEC baffle with open back volume (50mW, 1cm)

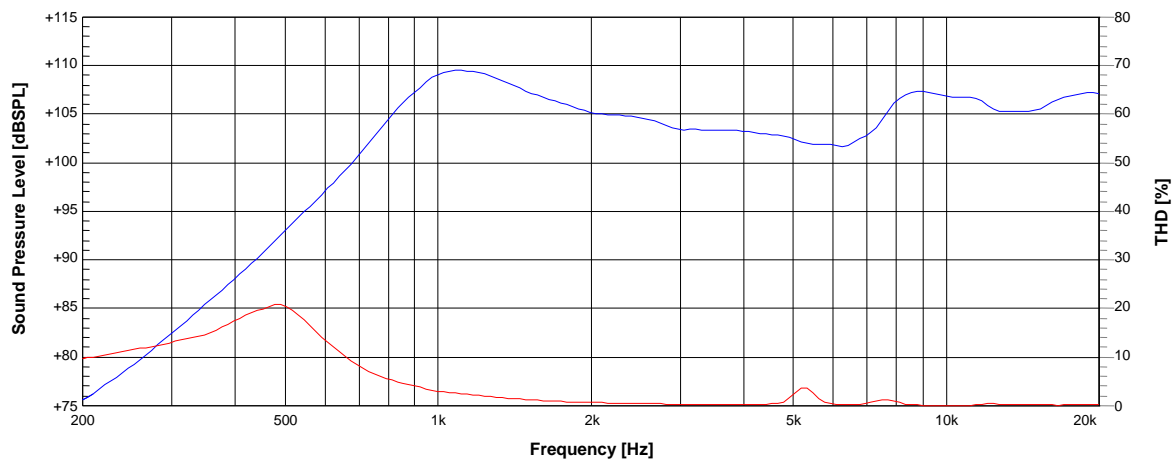

[Back](#)

## GRACE 14x20x4

Speaker GRACE 14 x 20 x 4mm :



### Typical applications :

- Sealed back volume not necessary due to high resonance frequency
- The speaker has damping mesh on the back, no special mesh needed
- High sensitivity, power ratio up to 500mW even in free field

### Frequency Response :

Closed back volume (3 ccm) with front resonator

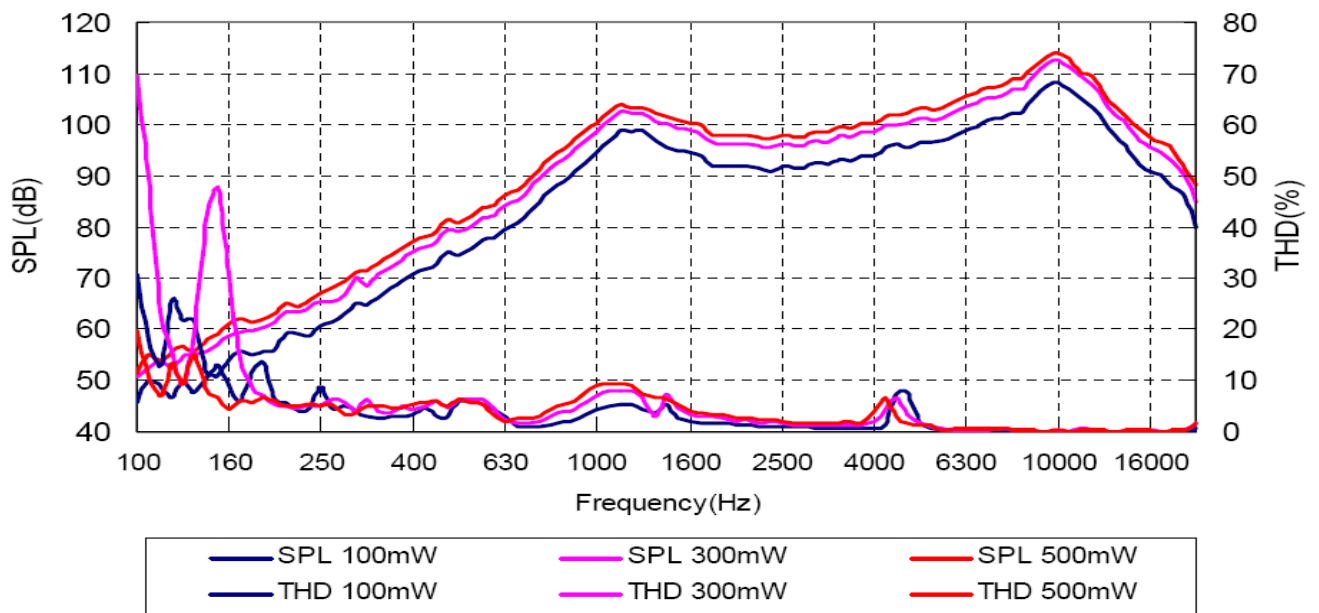

Frequency response and THD in free field, 5cm distance, 100mW-300mW-500mW

[Back](#)

## MALT EVA 16x3

### Speaker MALT EVA 16 x 3mm :

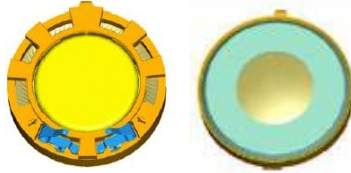

#### Specifications :

- **Impedance :** 8Ω
- **Sensitivity :** 74.5dB @ 1W/1m
- **Power Ratio \*\* :** 0.3W Nom. / 0.8W Max
- **Resonance Frequency :** 600Hz
- **Frequency Range \* :** 700Hz – 10kHz
- **Weight :** 1.14g
- **Thickness :** 3.05mm

\*) in typical application, at -3dB points after resonance peaks, without EQ correction

\*\*) using shaped noise signal according to NXP specification sheet

#### Key features :

- Good performance/price ratio
- Mature product family
- Plastic cover ensures low interference with antenna
- Spring contacts and side venting design for easy pick&place

#### Product range :

- 2403 260 00024 : with spring contacts (WD20673/Y8L)

#### Frequency Response : measured in IEC baffle with open back volume (50mW, 1cm)

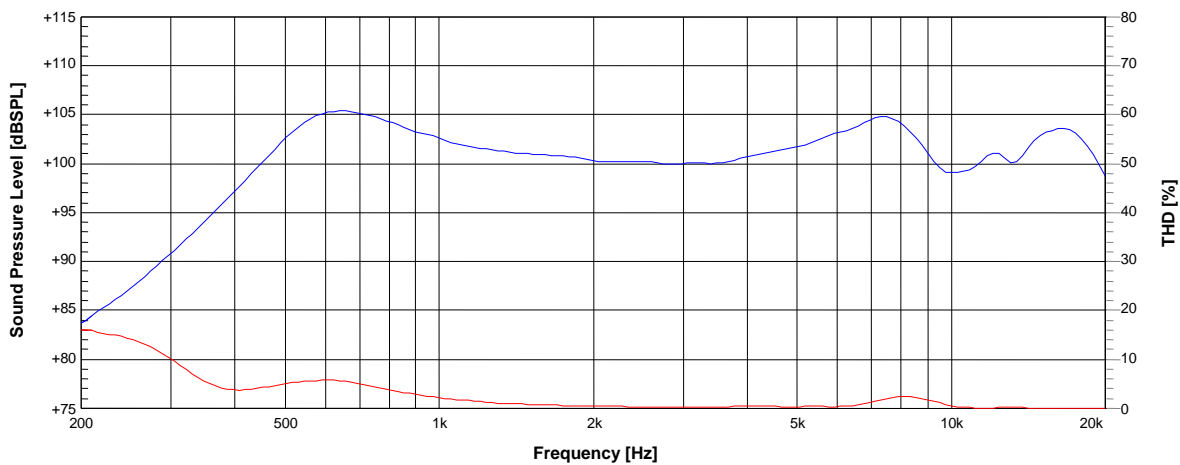

[Back](#)

## MALT EVA 16x3

### Speaker MALT EVA 16 x 3mm :

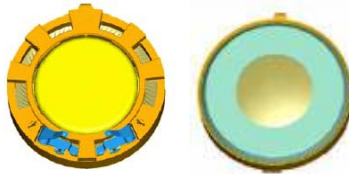

#### Typical applications :

- For operation in closed back volumes
- Side firing or front firing applications
- Very slim design for thin mobile phones

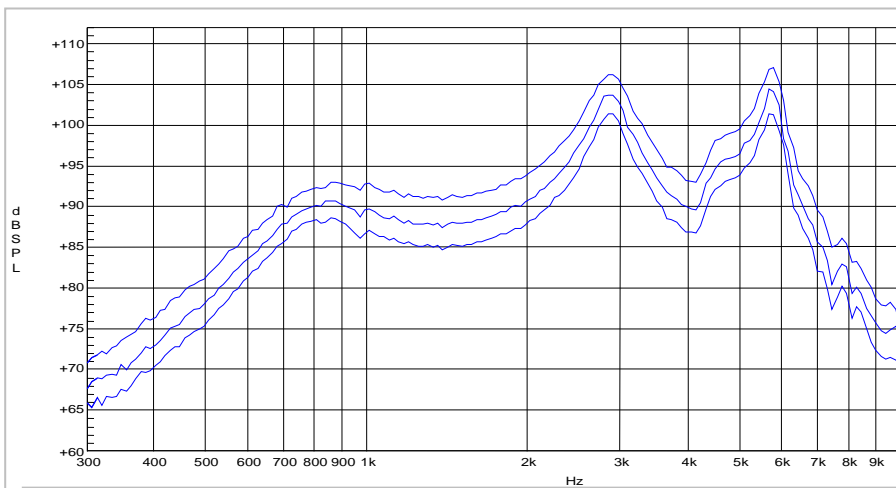

**FREQUENCY RESPONSE :**  
 closed back volume (1ccm) sealed  
 with a double front resonator  
 measured in 5cm free field  
 Measured at 100 – 200 – 500 mW

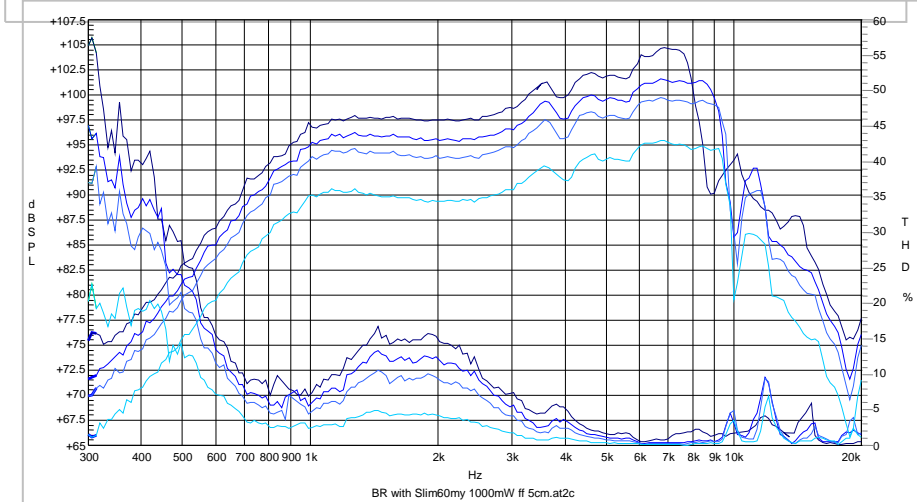

**FREQUENCY RESPONSE :**  
 back volume (5ccm)  
 with a bass reflex port  
 measured in 5cm free field  
 Measured at 100–300–500–1000mW

[Back](#)

## MFD 16.4x4.7

Speaker MFD 16.4 x 4.7mm Multifunctional Vibrator :

**New product**



### Specifications :

- Impedance : 8Ω
- Sensitivity : 74dB @ 1W/1m
- Power Ratio \*\* : 0.5W Nom. / 1W Max
- Resonance Frequency : 540Hz
- Frequency Range \* : 650Hz – 15kHz
- Vibra : 157Hz
- Acceleration : 6.5 m/s<sup>2</sup> (80 grams)

### Key features :

- Built-In Vibrator saves cost for separate vibrator
- Usage as speaker/receiver/vibrator or speaker/vibrator
- Spring contacts for firm connection

### Product range :

- 2403 263 00077 : with spring contacts

**Frequency Response :** measured in IEC baffle with 2ccm back volume (125mW, 1cm)

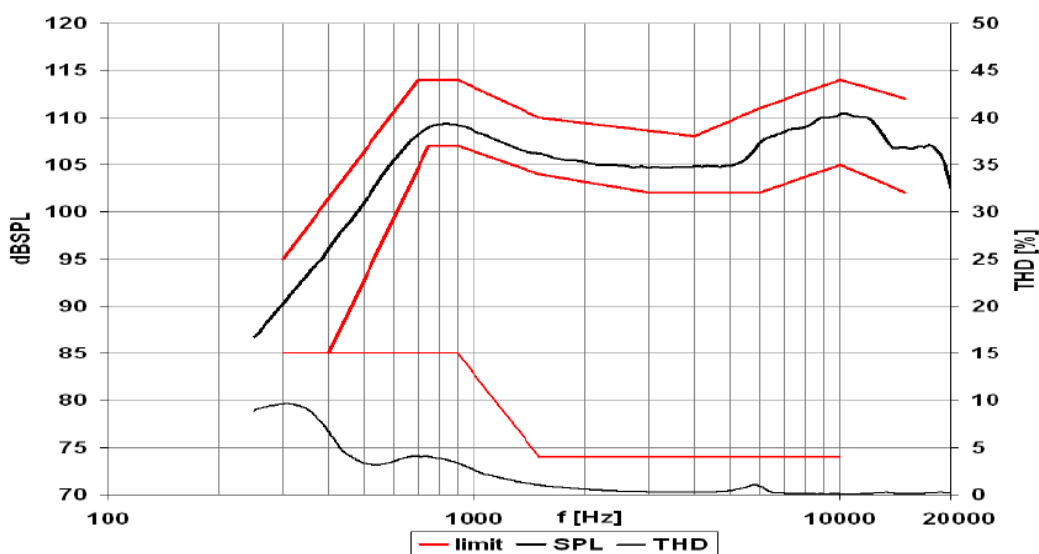

[Back](#)

## MFD 16.4x4.7

### Speaker Multifunctional Vibrator MFD 16.4 x 4.7mm :



#### Typical applications :

- Low-cost phones
- Vibrator, Speaker & Receiver combined

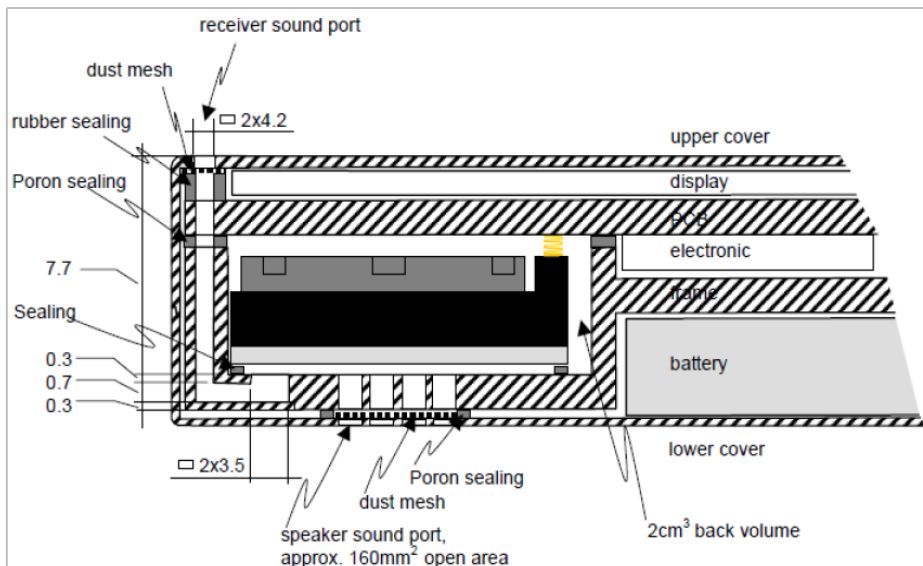

Figure 1 :  
Schematic drawing

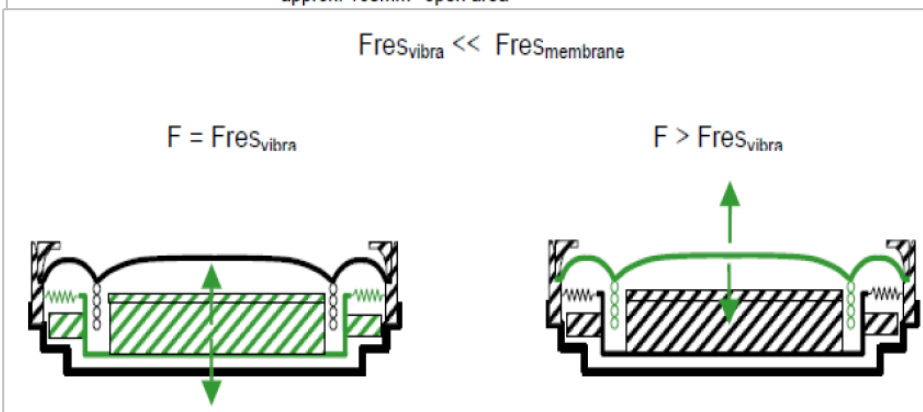

Figure 2 :  
Vibra function principle

[Back](#)

## HPFS 28x6

Speaker HPFS 28 x 6mm (High Performance flat speaker) :



### Specifications :

- **Impedance :** 8Ω
- **Sensitivity :** 86.5dB @ 1W/1m
- **Power Ratio \*\* :** 0.5W Nom. / 1W Max
- **Resonance Frequency :** 700Hz
- **Frequency Range \* :** 450Hz – 8kHz
- **Weight :** 4.9g
- **Thickness :** 6.0mm

\*) in typical application, at -3dB points after resonance peaks, without EQ correction

\*\*) using shaped noise signal according to NXP specification sheet

### Key features :

- Low Resonance Frequency
- High PHC
- High SPL
- Customized front gasket & rear pad

### Typical applications :

- Automotive applications : speech, alarm, melodies tones in cars
- PTT phones
- Loud hearing for cordless phones and base stations
- Hands-free applications for 2 band radio, car communication and professional use

### Product range :

- 2403 258 13022 : with spring contacts (WD11903/Y8H)

**Frequency Response :** measured in IEC baffle with open back volume (100mW, 10cm)

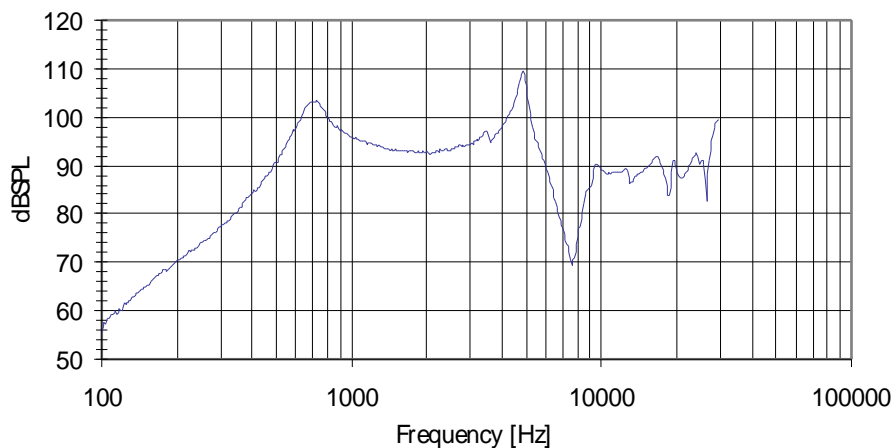

[Back](#)

## CONTACTS

Megatron AG  
Fabrikstrasse 2  
CH- 8722 Kaltbrunn

[www.megatron.ch](http://www.megatron.ch)  
[sales@megatron.ch](mailto:sales@megatron.ch)  
Tel.: +41 (0) 55 617 00 88  
Fax: +41 (0) 55 617 00 89