

FERROXCUBE

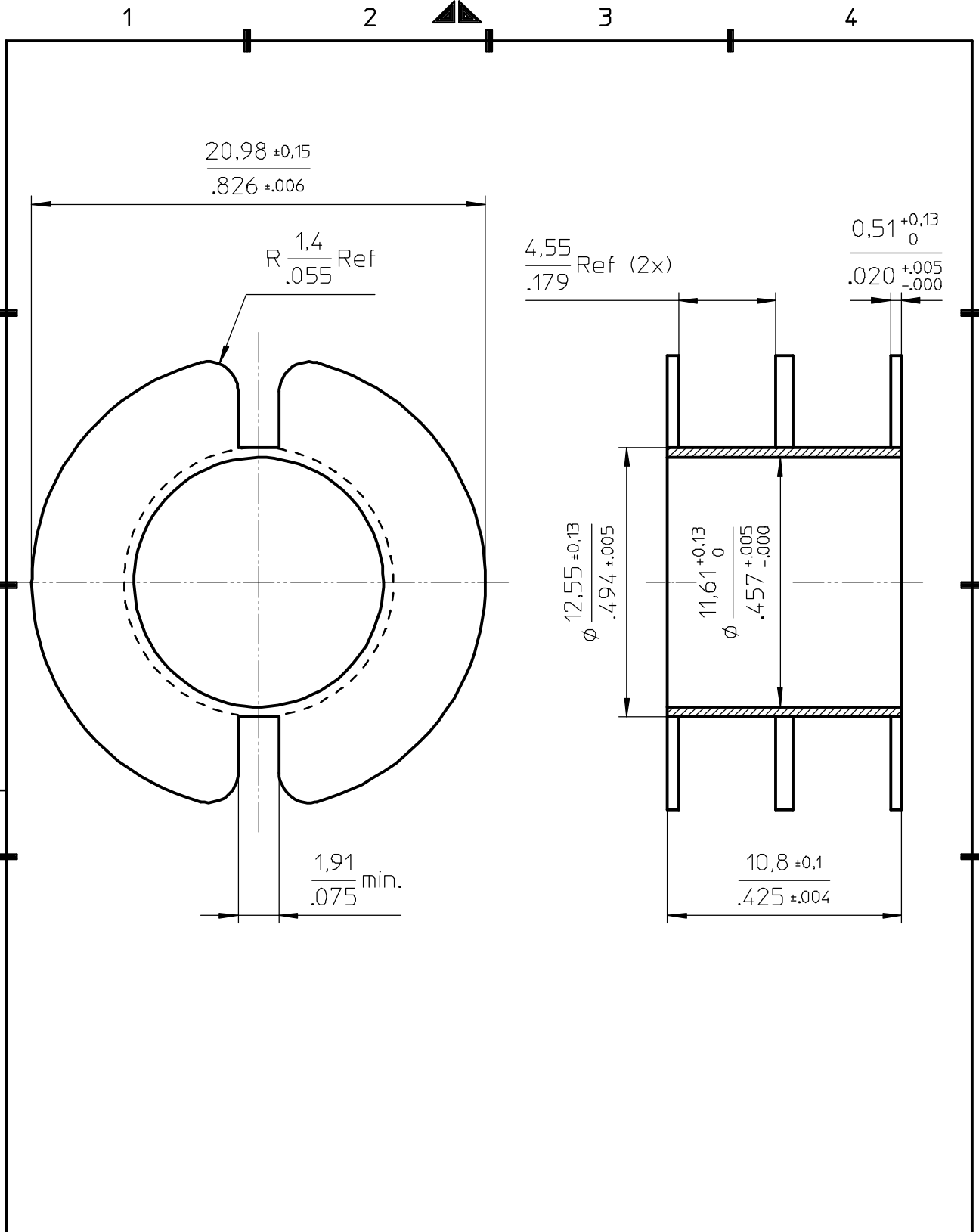
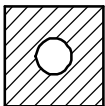
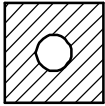

Coil former material: Delrin 900 (POM).
 UL file number: E66288 - UL94HB.

CP-P26/16-2S-A		4335 000 26211		01-06-01
				02-11-04
NAME NAAM	JON	SUPERS. VERV	1 SH BL	SH BL 112 - 001
MPA	CHECK CONTR.	DAT.	Property of Eigendom van	© FERROXCUBE 2002
				A4