

FERROXCUBE

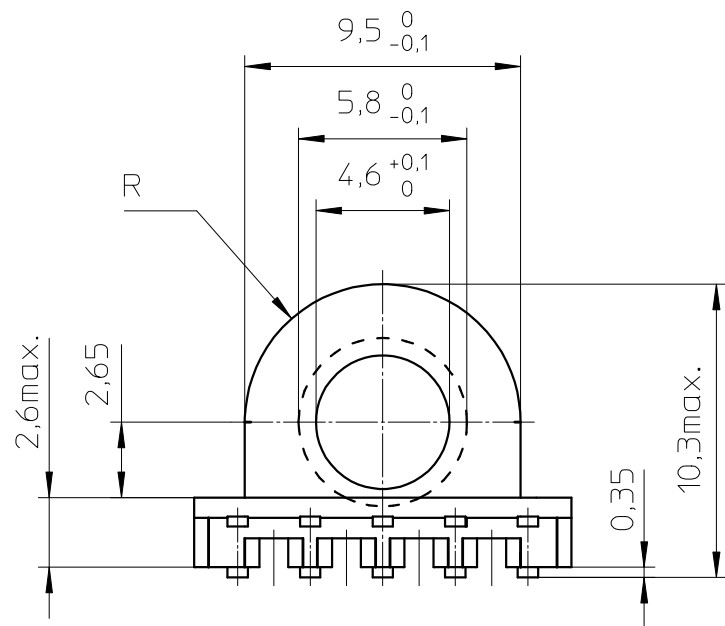

PROPOSED PAD ARRANGEMENT:

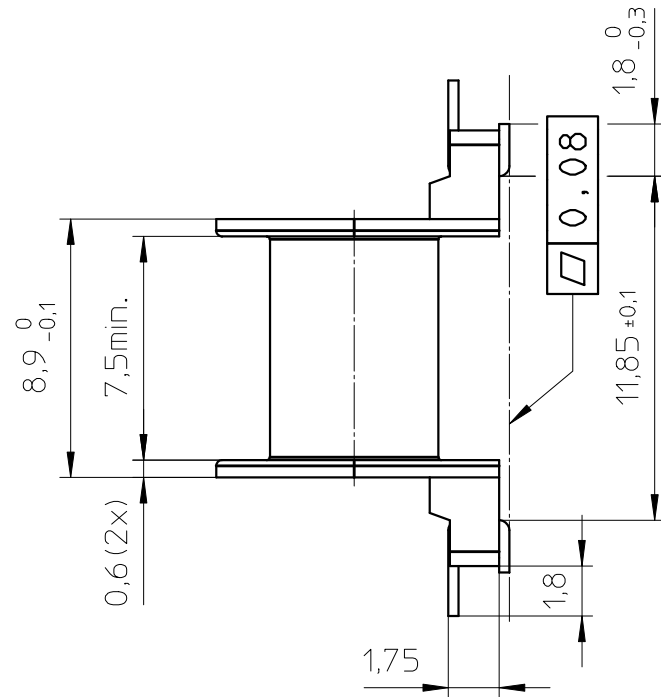
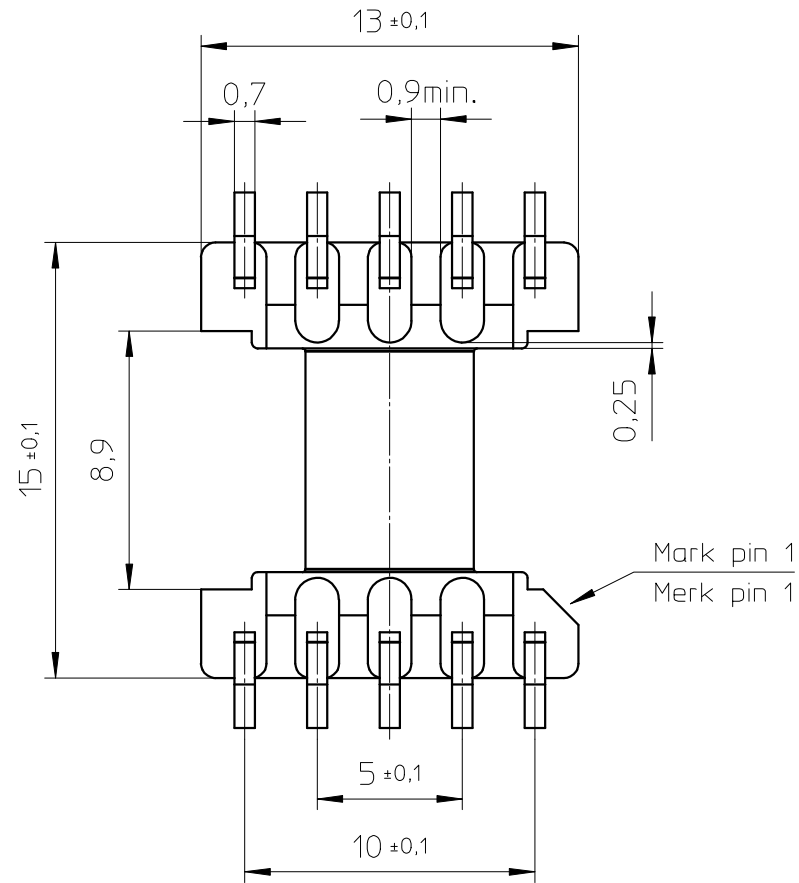
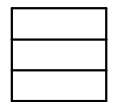
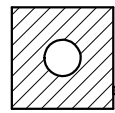
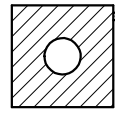
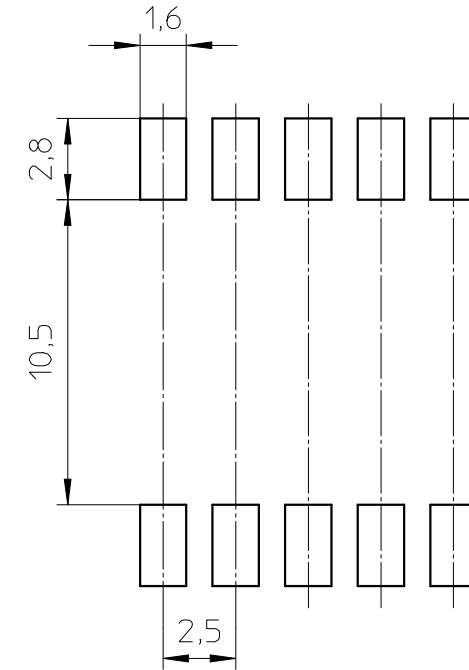

- Coil former material: Sumikon PM9630 (PF), glass-reinforced.
UL file number: E41429 - UL94V-0.
- Pin material: CuSn, Sn plated.
- Max. operating temp.: acc. to IEC 60 085 class F, 155°C.
- Resistance to soldering heat: acc. to IEC 60 068-2-20 Part 2, Test Tb, method 1B, 350°C-3.5s
- Solderability: acc. to IEC 60 068-2-20 Part 2, Test Ta, method 1, 235°C-2s
- Min. winding area: 13,5 mm².
- Mean length of turn: 23,8 mm.

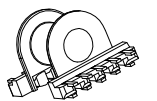

CLASS.NO.	CSHS-EP13-1S-10P-T		4322 021 03201	1999-01-05
2000-08-28				2000-08-28
				2005-03-11
NAME NAAM MPA	M.Veekens	SUPERS. VERV.	001 SH SH BL BL 112 - 001	069
CHECK CONTR.	DAT.	99-01-05	Property of Eigendom van	© FERROXCUBE 2000
				A3